

...dal 1951

LADDER
WIRE
ROPE



FACTORY

fabbrica
scale, ponteggi,
e

metalliche

PER ARGANI, GRU, PARANCHI, TESATURE LINEE E USO COMMERCIALE

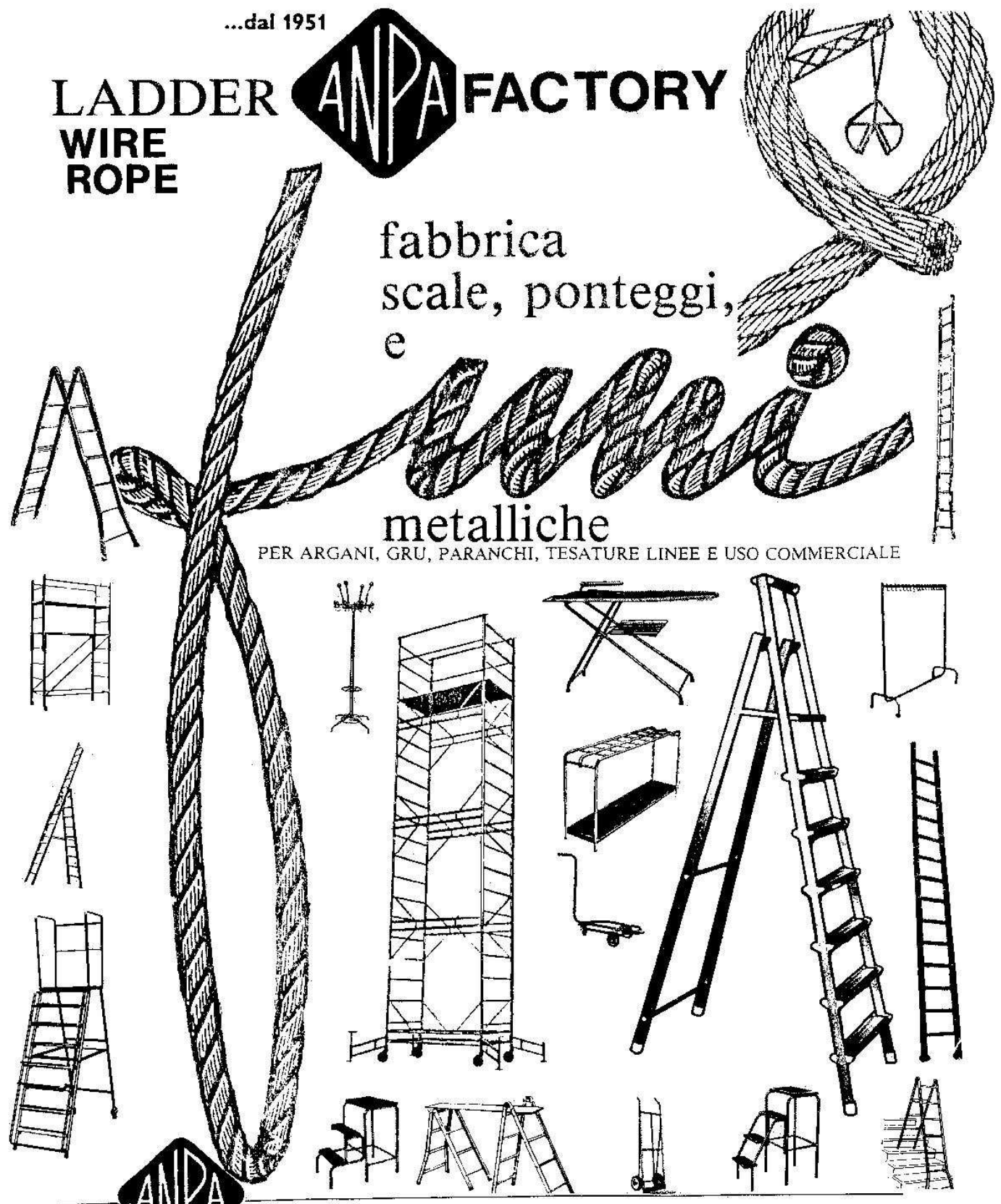

FABBRICA SCALE, PONTEGGI, CARRELLI, ACCESSORI D'ARREDAMENTO E FUNI IN ACCIAIO PER ARGANI, GRU, PARANCHI, TESATURE LINEE E USO COMMERCIALE
20127 MILANO - ITALIA - VIA G. ROVETTA 8 - Turro

TEL / FAX (+39) 0226146609

C.C.I.A.A. Milano N. 780955 EXPORT MATR. N. 989213 P. IVA 00210190153

WWW.AN-PA.IT vendite@an-pa.it



...nel 1951 li abbiamo
lanciati per primi sul
mercato italiano

SCALE E SGABELLI

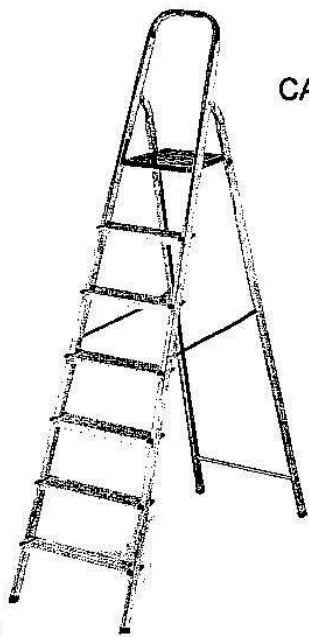
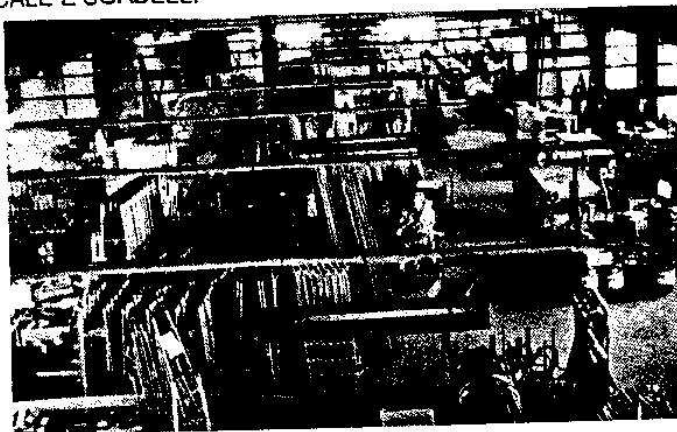

CATALOGO
FORMATO
RIDOTTO

dal 1951



Art. 396
SCALA ECON tutt'acciaio
da 3=4=5=6=7=8 gradini

TABELLE ALTEZZE SCALE

gradini	altezza a piombo rispetto scala aperta cm.	altezza totale scala chiusa cm.	peso kg.
3	58	134	4
4	91	157	4.500
5	114	180	5
6	137	203	6
7	159	228	7
8	182	248	8
9	202	272	9
10	228	295	10
11	261	350	11
12	285	375	12
13	308	400	14
14	332	425	15
15	355	450	16

A NORME
DPR 547
DPR 164
EN 131
MADE IN ITALY



ART 398
SCALA EXPORT alluminio
tubi 40X20X1,5 quadrupla rivettatura
da 3=4=5=6=7=8=9=10 gradini



ART. 400
SCALA MINI PROFESSIONAL ALLUMINIO
tubi 45X20 da 3-4-5-6-7-8 gradini
passanti e ribordati senza viti,
rivetti e ribattini

GRANDE STABILITÀ
ASSOLUTA SICUREZZA
LUNGA DURATA

CATALOGO GENERALE E LISTINI PREZZI A RICHIESTA

DAL 1951



SCALE, SGABELLI



Art. 410 Sgabello poggia piedi in acciaio

CERNIERE D'APERTURA



gradini ribordati

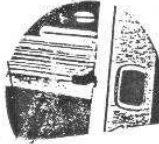

**GRANDE STABILITÀ
ASSOLUTA SICUREZZA
LUNGA DURATA**



Art. 399
SCALA PROFESSIONAL alluminio
tubi 50X22 da 3 a 8 gradini
e da 66X22 da 9 a 12 gradini
passanti e ribordati senza
viti, rivetti e ribattini
da 3=4=5=6=7=8=9=10=11=12 gradini

TABELLE ALTEZZE SCALE

gradini	altezza a piombo in piano scala aperta cm.	altezza locale acciaio chiuso cm.	peso all. Kg.
3	68	134	4
4	91	157	4,500
5	114	180	5
6	137	203	6
7	159	226	7
8	182	249	8
9	202	272	8
10	226	295	10
11	241	350	11
12	285	375	12
13	306	400	14
14	332	425	15
15	355	450	16

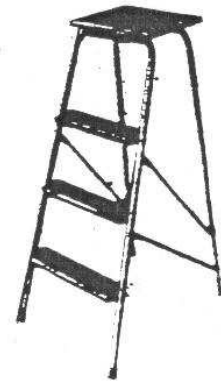

Art. 412 Scaleo chiudibile in acciaio a 3 e 4 gradini

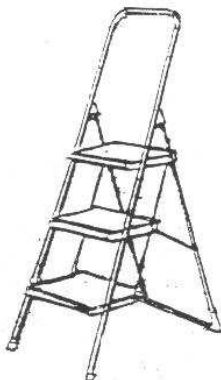

Art. 409
SCALEA in acciaio
a 2 gradini
a 3 gradini
a 4 gradini

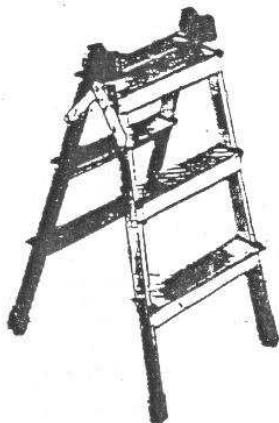

Art. 416
SCALEA Fritolana in duralluminio
a doppia salita
da 3-4-5-6-7-8-9-10 gradini

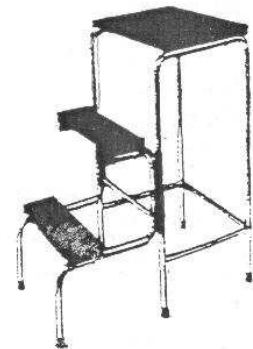

Art. 414 Sgabello ribaltabile in acciaio a 3 gradini.
Misure: cm. 40X27X62 di h.
ingombro aperto cm. 52

Art. 415 Sgabello ribaltabile in acciaio a 4 gradini.
Misure: cm. 40X27X82 di h.
ingombro aperto cm. 87



SCALE SPECIALI E PONTEGGI

Art. 386
SCALA in corda

MONTANTI IN FUNE DI NYLON ø mm. 16
GRADINI ALLUMINIO ANTISDRUCIOLEVOLI PIOLI ø mm. 25
GANCI ACCIAIO ZINCATI ø mm. 12
LARGHEZZA ESTERNA cm. 35



A NORME
DPR 547
DPR 164
EN 131

Art. 430
Scala a carrello in acciaio verniciato:
o in Duraluminio

H		base
piatt.	tot.	
100	200	64 x 97
150	250	74 x 124
200	300	84 x 150
250	350	94 x 176
300	400	104 x 202
350	450	110 x 228
400	500	120 x 250

per magazzini, uffici, biblioteche, cimiteri ecc. ecc.

Art. 429/AL e 429/AC
SCALE "Semplici d'appoggio"
in alluminio con gradini piani
rettangolari da mt.: 2-2,50-3-3,50-4



Indispensabili per
qualsiasi lavoro di
manutenzione a
fabbricati:
capannoni,
ville, ecc. ecc.

anche a
Imbriacatori
Muratori
Tappezziere
Idraulici
Giardinieri
Elettricisti
ecc. ecc.



Art. 431/A
SCALE componibili in alluminio e vetroresina
in tre tronchi da mt. 2,50 h scala aperta mt. 5,50
in tre tronchi da mt. 3 h scala aperta mt. 7
in tre tronchi da mt. 3,50 h scala aperta mt. 8,50
in tre tronchi da mt. 4 h scala aperta mt. 10
in tre tronchi da mt. 4,40 h scala aperta mt. 11,14
h scala sfilata mt. 5,50
h scala sfilata mt. 7
h scala sfilata mt. 8,50
h scala sfilata mt. 10
h scala sfilata mt. 11,14

Art. 380
SCALA A CHIOCCIOLA in acciaio verniciato colore bianco crema gradini rivestiti in gomma nera oppure in moquette grigia da Ø1000 a 2000 = H 2100 a 3979 (il Ø del foro deve essere maggiorato di mm. 100)

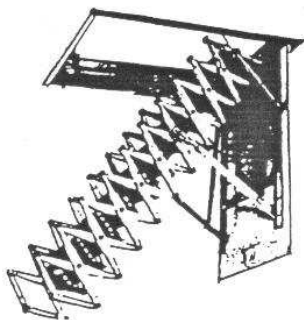

Art. 382 ZX
SCALA RETRATTILE da soffitto a pantografo in acciaio zincata foro botola mm.

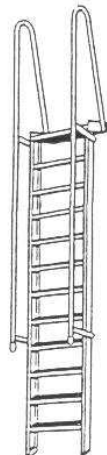

Art. 384
SCALA D'appoggio
con piattaforma
e maniglie sbarco

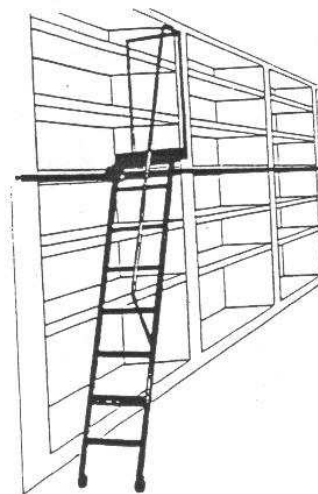

Art. 385
SCALA scorrevole

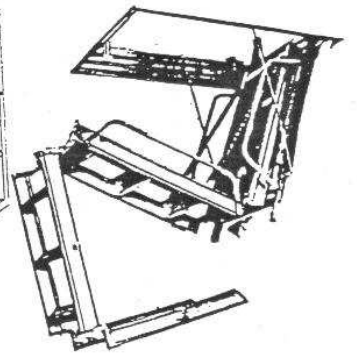

Art. 383 - PK
SCALA RETRATTILE da soffitto IN 4 TRONCHI
in acciaio zincata foro botola mm.

SCALE SPECIALI E PONTEGGI

Art. 433

Scala multipla telescopica a 4 combinazioni.

Versioni: 1° Scala d'appoggio sfilata
 2° Scala aperta a cavalletto
 3° Scala zoppa usabile su scalinate
 4° Scala scorporata a PONTEGGIO

Grad. n°	Chiusa tot. m	Cavalletto m	ro m
6+6	0,97	1,46	3,00
7+7	1,25	1,71	3,55
8+8	1,25	1,96	4,10
9+9	1,53	2,23	4,64
10+10	1,53	2,51	5,22
11+11	1,81	2,82	5,80
12+12	1,81	3,10	6,35

**GRANDE STABILITA
 ASSOLUTA SICUREZZA
 LUNGA DURATA**

**A NORME
 DPR 547
 DPR 164
 EN 131**

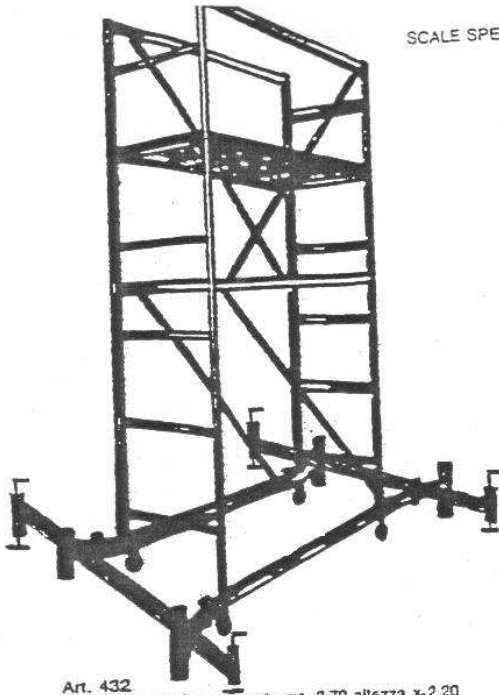

Art. 432
 PONTEGGIO in acciaio da mt. 2,70 altezza x 2,20 x 0,90 di base e 1,55 x 0,53 di piano lavoro

PONTEGGIO in acciaio da mt. 4,00 altezza x 2,20 x 0,90 base e 1,55 x 0,53 piano lavoro

STRUTTURA ACCIAIO TUBO TONDO ZINCATO a mm. 52 montanti
 QUATTRO RUOTE GIREVOLI PIVOTANTI GOMMATE a mm. 80
 QUATTRO STABILIZZATORI
 DIMENSIONE BASE COMPRESI STABILIZZATORI m. 2,21 x 0,91
 ALTEZZA CAMPATA m. 1,28
 ALTEZZA BASAMENTO cm. 16
 DIMENSIONI PIANO DI LAVORO Kg. 10 m. 1,55 x 0,53



VERSIONE 1



VERSIONE 3°

Art. 432/Z ZOPPO

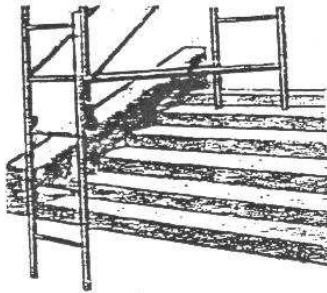

Art. 433/S Stabilizzatore di base

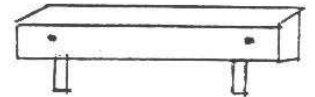

VERSIONE 2°



VERSIONE 4°

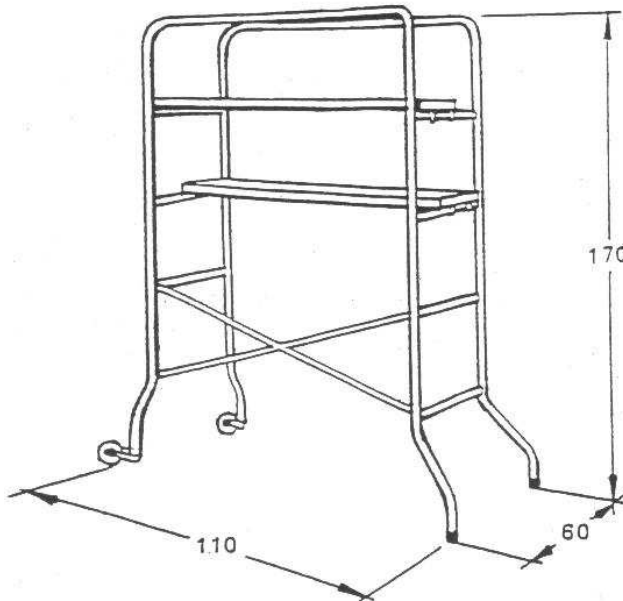

Art. 434
 PONTEGGIO in acciaio da mt. 1,70 altezza x 110x0,60 trasformabile in Scala da mt. 3



MULTIPLA
 è la prima scala telescopica
 al mondo
 presentata al MACEF 1971

Registro A Protocollo N. 26089 A/ 71

CAMERA DI COMMERCIO INDUSTRIA ARTIGIANATO E AGRICOLTURA DI MILANO
 SERVIZIO DEI BREVETTI PER INVENZIONI, MODELLI E MARCHE

COPIA DEL VERBALE DI ESPONTO PER BREVETTO D'INVENZIONE INDUSTRIALE
 (Art. 21 del R.D. 5-1-1918 n.14)

L'anno 1971 il giorno dicinove del mese di giugno
 alle ore undici e minuti zero nove

PAPPOLIA Antonio
 il signor
 di nazionalità italiana residente CHERUSCO SUL NAVIGLIO (Milano)

Via ----- a mezzo mandatario UFF. BREV. JUC. MOTTANO I.G.
 ed elettivamente domiciliato agli uffici di legge a Milano - Via Padova, 217
 presso il mandatario
 ha presentato e ha sottoscritto:

- Domanda, in base alla L. 500, di BREVETTO PER INVENZIONE INDUSTRIALE avente per

TITOLO:

SCALA COMPLETAMENTE AD ELEVATA MULTIFUNZIONALITA' DI ESPONTO.

La domanda, le descrizioni ed i disegni sono stati firmati dal richiedente e da me confermati e bollati col timbro d'ufficio.



PONTEGGI E CARRELLI DA TRASPORTO

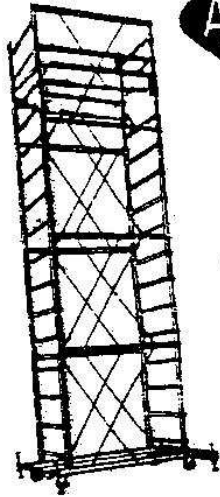

A NORME
DPR 547
DPR 164
EN 131

Art. 436
Ponteggio in acciaio da mt. 7,50
STRUTTURA ACCIAIO TUBO TONDO ZINCATO..... ø mm. 42 montanti
QUATTRO RUOTE GIREVOLI PIVOTTANTI GOMMATE ø mm. 150
DIMENSIONE BASE COMPRESI STABILIZZATORI..... m. 2,34 x 1,54
ALTEZZA CAMPATA..... m. 1,50
ALTEZZA BASAMENTO..... cm. 23
DIMENSIONI PIANO DI LAVORO..... m. 1,74 x 0,90

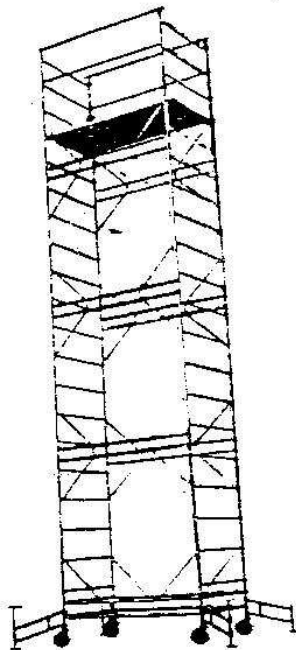

Art. 437
Ponteggio in acciaio da mt. 9,60 | 11,60 | 13,60

STRUTTURA ACCIAIO TUBO TONDO ZINCATO..... ø mm. 50 montanti
QUATTRO RUOTE GIREVOLI PIVOTTANTI GOMMATE ø mm. 200
DIMENSIONE BASE COMPRESI STABILIZZATORI..... m. 2,74 x 1,84
ALTEZZA CAMPATA..... m. 2,00
ALTEZZA BASAMENTO..... cm. 44
DIMENSIONI PIANO DI LAVORO..... m. 1,97 x 1,06
PIANO DI LAVORO
FERMAPIEDI LEGNO
BRACCIO CON CARRUCOLA



Art. 451
Carrello per
sacchi e casse in acciaio
ruote da mm. 200

Art. 450
Carrello triangolare in acciaio
a 3 ruote da mm. 100

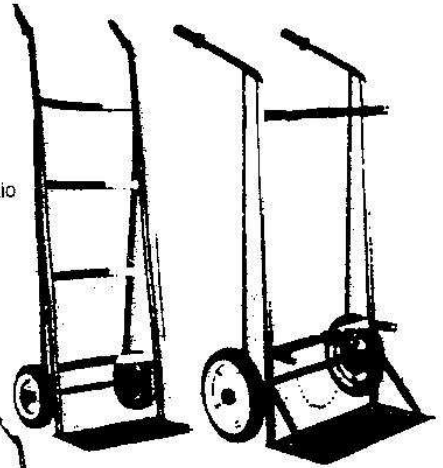

Art. 454
Carrello per 2 bombole in acciaio
ciao a 2 ruote da mm. 250

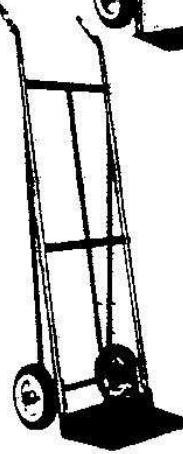

Art. 453
Carrello per sacchi, pacchi e casse in
acciaio verniciato a 2 ruote da mm. 180



Art. 455
Carrello a 2 ripiani da cm. 53 x 85 x 78
in acciaio verniciato per accessori
utensili in officine, laboratori
svariati usi familiari.



Art. 452
Carrello a pianale da cm. 52 x 80
allungabile sino a cm. 145 in acciaio
zincato a 4 ruote da mm. 125



ART. 462
Carrello portarifiuti
richiudibile, sacchi
confezione da 50 pezzi

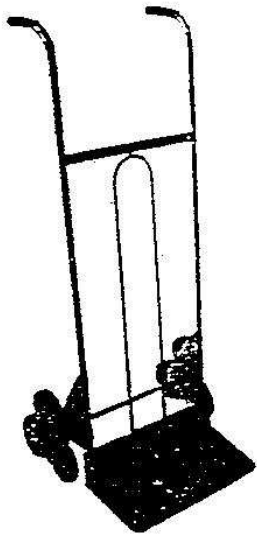

Art. 456
CARRELLO a 6 ruote
per gradini

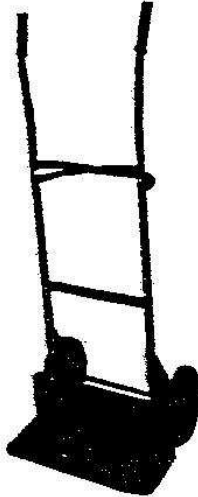

Art. 458
CARRELLO per casse
ruote gonfiabili Ø
mm. 260.



Art. 455
Carriola in acciaio SENISMONTATA, MANICO PIEGATO
telaio tubolare, cassa stampata ZINCATA, capacità LL. 70.

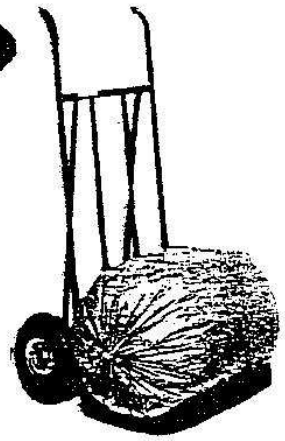

Art. 460
CARRELLO PORTABAGAGLI SACCHI
e casse con pedana
rimovibile piastra cm. 60 X 50

ARTICOLI CASALINGHI



Art. 461 CARRELLO
TRASFORMABILE IN TRE POSIZIONI
2 ruote Ø 200 - 1 ruota Ø 125
Dim. mm 1200 x 500
Piastra mm 420 x 220
Peso Kg 22
Portata Kg 300/350

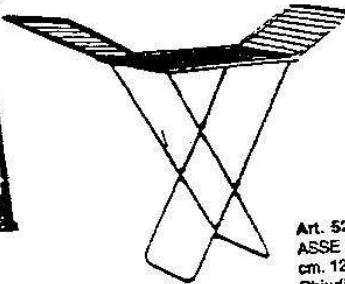

Art. 521
ASSE STIRO "Professional" in acciaio cromato con piano da
cm. 120x37 in pannello laminato formica e coperta metallizzata.
Chiudibile e regolabile in 4 diverse altezze



Art. 523
Stirone spruzza-biancheria
moplen stampato.

Art. 608
STENDIBIANCHERIA a cavalletto
con 2 prolunghe laterali
in acciaio



Art. 614
STENDIBIANCHERIA a pantografo
in acciaio
da cm. 70-80-100-120

Art. 522
Braccio stiramaniche

Piano cm. 42 x 11 in acciaio, corredato da
relativa coperta metallizzata.

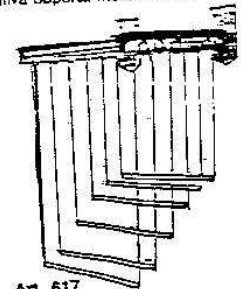

Art. 617
STENDIBIANCHERIA a saliscendi
in acciaio
da cm. 100-120-140-160



Art. 527
Appendibili da parete a 7 posti chiudibile in alluminio



Art. 533
Maniglione da cm. 30-40-50-60
in ottone

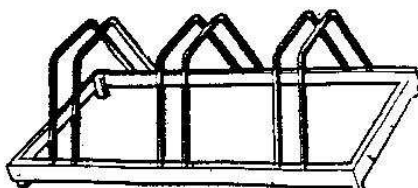

Art. 738 PORTABICICLETTE ZINCATE a 2 posti
- 3 -
- 4 -
- 5 -

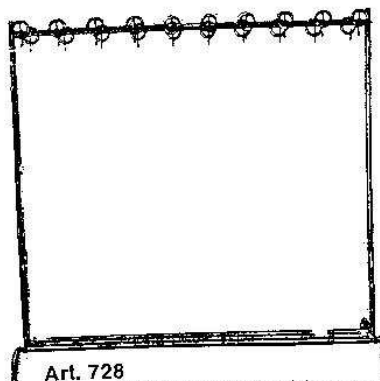

Art. 728
Attaccapanni a stender in acciaio smontabile con appendibili in alluminio
misure: altezza cm. 150
larghezza cm. 140
con 2 prolunghe laterali da cm. 30
(adatto per alberghi, ristoranti, comunità ecc. ecc.)

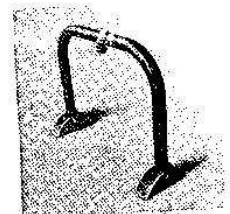

ART. 750
DISSUASORE DI SOSTA
piastre di fissaggio in acciaio zincato
provviste di fori per lucchetto

ARTICOLI D'ARREDAMENTO NEGOZI



Art. 730
Stender porta-abiti in acciaio, con due prolunghe laterali da 30 cm., smontabile.
misure: altezza cm. 150
larghezza cm. 140
(adatto per esposizione)

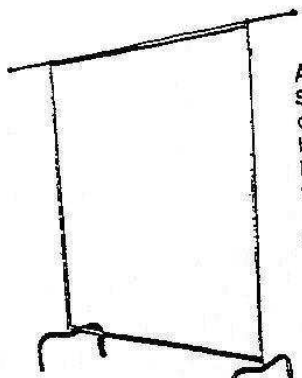

Art. 710
Sgabello
in acciaio con sedile imbottito in sky colore verde
altezza cm. 85

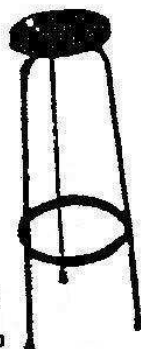

ART. 712
Sgabello girevole in acciaio con sedile in legno nero
altezza cm 60

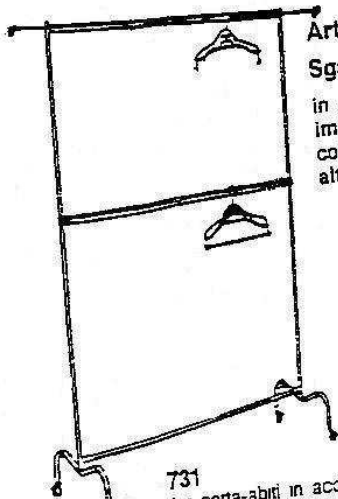

731
Stender porta-abiti in acciaio con due prolunghe laterali da cm. 30 e due aste smontabile.
misure: altezza cm. 195
larghezza cm. 140



Art. 711
Sgabello

in acciaio con sedile imbottito in sky colore verde
altezza cm. 45

Art. 737
Leggio-tavolino trasportabile in acciaio con rotario girevole e inclinabile in laminato plastico colore noce

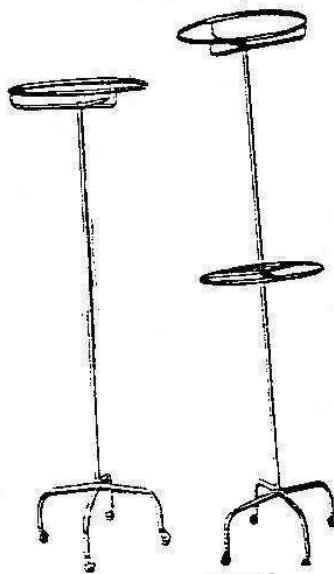
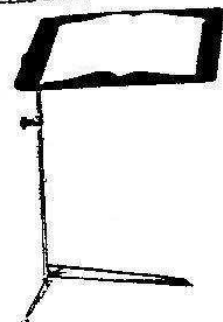

Art. 732
Stender porta-abiti smontabile girevole.

Art. 733
Stender porta-abiti smontabile a 2 piani

Art. 724
APPENDIABITI da parete in acciaio nero
cm. 80 a 4 posti

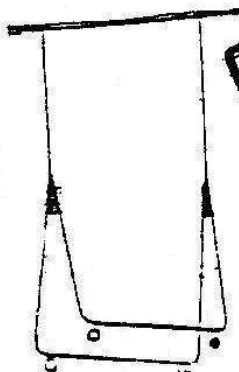
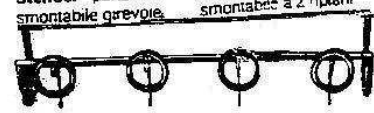

Art. 717
Porta ombrelli in acciaio nero a 8 posti CM 52X26 a 16 posti CM 94X26

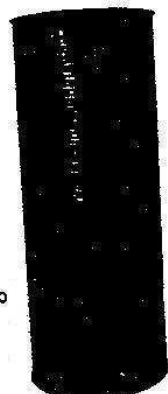
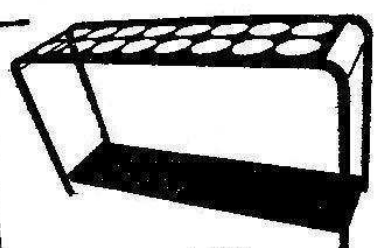

ART. 739
Posacenere gettacarta verniciato

Art. 735
Stender telescopico, porta-abiti prolunghe laterali da cm. 30.
misure: cm. 80 x 150
riducibile chiuso a cm. 80 x 80
(adatto per rappresentanti)



Art. 719
Attaccapanni



ART. 716
Portaombrelli in acciaio



ART. 721
Carrelli per la spesa



ART. 723
POLTRONA in pl. stica
colori: bianco o verde



ART. 726
Attaccapanni a 6 posti in plastica cromata



ART. 740
Posacenere inox



ART. 749
Patturiera con secchio Lt. 5